

Particle Discovery at the LHC



Sally Seidel

University of New Mexico

20 October 2017

APS Four Corners Meeting

The LHC experiments have announced the discovery of several new particle states - in addition to the Higgs.

These include:

- $\chi_b(3P)$
- $B_c^\pm(2S)$
- $\Xi_b'^0$
- $\Xi_b'^-$ and Ξ_b^{*-}
- Ξ_{cc}^{++}
- 5 excited states of the Ω_c^0
- 3 tetraquarks X
- 2 pentaquarks P_c

This talk is about the particles *other than* the Higgs. We have 4 types of objects here: **mesons** (qq), **baryons** (qqq), **tetraquarks** (qqqq), and **pentaquarks** (qqqqq).

- $\chi_b(3P)$: $\{b\bar{b}\}$ [ATLAS, 2011]
- $\Xi_b'^0$: $\{usb\}$ [CMS, 2012]
- $B_c(2S)$: $\{\bar{b}c\}$ [ATLAS, 2014]
- $\Xi_b'^-$ and Ξ_b^{*-} : $\{dsb\}$ [LHCb, 2014]
- $P_c(4380)$ and $P_c(4450)$: $\{u\bar{c}cud\}$ [LHCb, 2015]
- $X(4274)$, $X(4500)$, $X(4700)$: $\{c\bar{c}s\bar{s}\}$ [LHCb, 2016]
- Ξ_{cc}^{++} : $\{ucc\}$ [LHCb, 2017]
- Ω_c^0 : $\{ssc\}$ [LHCb, 2017]

They all contain at least one heavy quark – charm or bottom, much heavier than the constituents of everyday matter. 3

These heavy quarks are
~500 times heavier than up
and down quarks

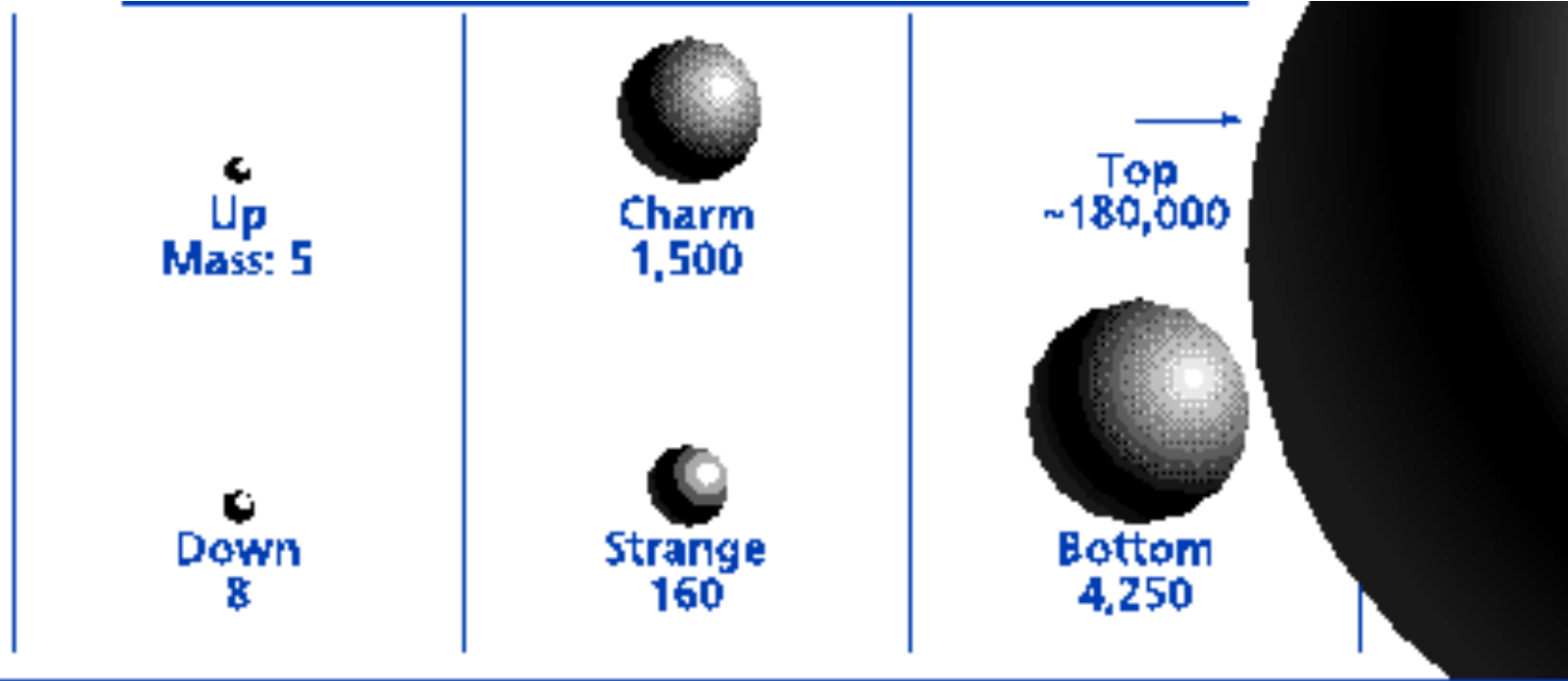

millions of electron volts

We're seeing them now because of the conditions the LHC provides for their production.

The LHC operates at luminosity and center of mass energies higher than those at previous colliders, allowing copious production of these massive quarks not possible previously.

	LHC	Tevatron
center of mass energy (TeV)	13	2 TeV
instantaneous luminosity (collision rate) in $\text{cm}^{-2}\text{s}^{-1}$	1.6×10^{34}	4×10^{32}

Increased rate of production of heavy quarks has 2 sources:

- The LHC instantaneous *luminosity is 40 times higher* than (for example) the Fermilab Tevatron's
- The protons that collide at the LHC are not simple 3-quark bags, but complex systems of valence quarks, sea quarks, and the gluon cloud that binds them. 80% of the events at the LHC are gluon-gluon collisions.

Production of heavy states increases with energy as gluons become increasingly likely to split to heavy quarks, including b and c.

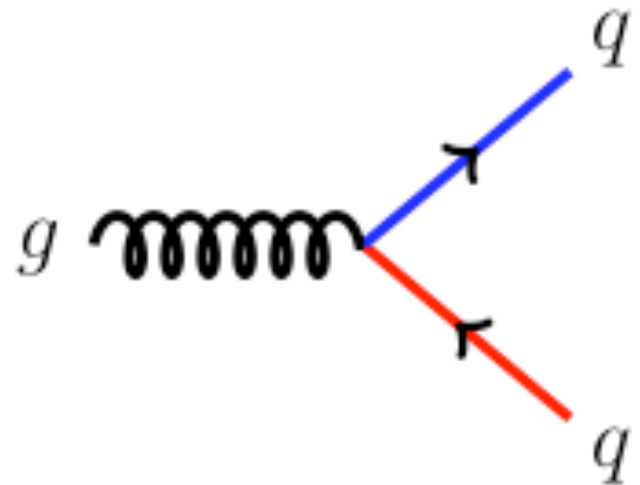

b-quark production cross section rising with energy

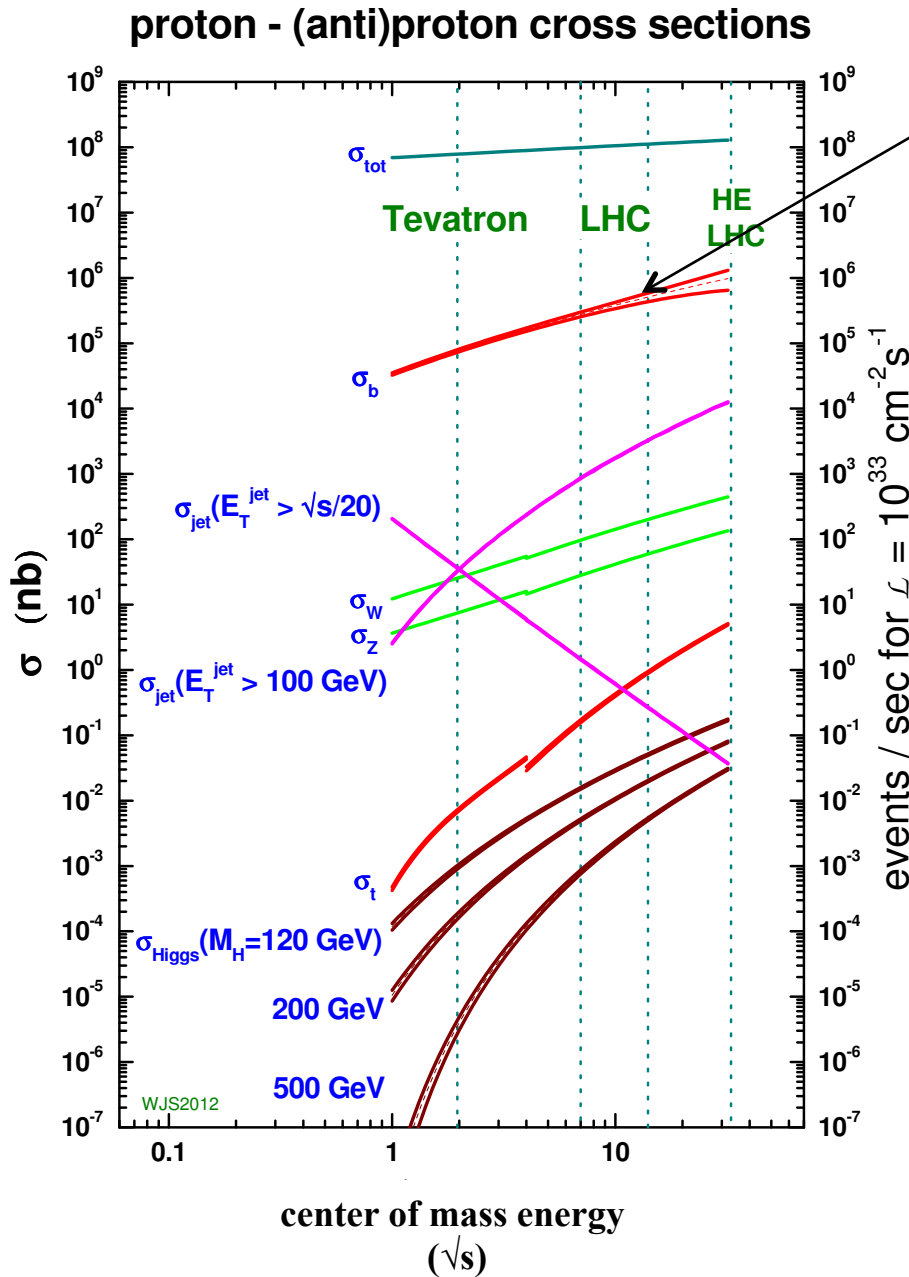

This makes possible studies of heavy quark states that were formerly inaccessible.

And although heavy quarks do not feature prominently in daily life, they turn out to be particularly useful in probing the strong interaction and searching for new physics.

All of the new particles have stories to tell, but we'll concentrate here on the $B_c(2S)$, which is the first excited state of the B_c , the bound state of bottom and charm.

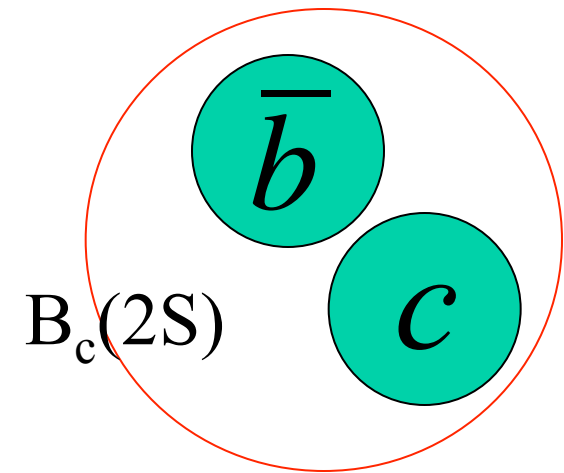

The discovery was made with the ATLAS detector

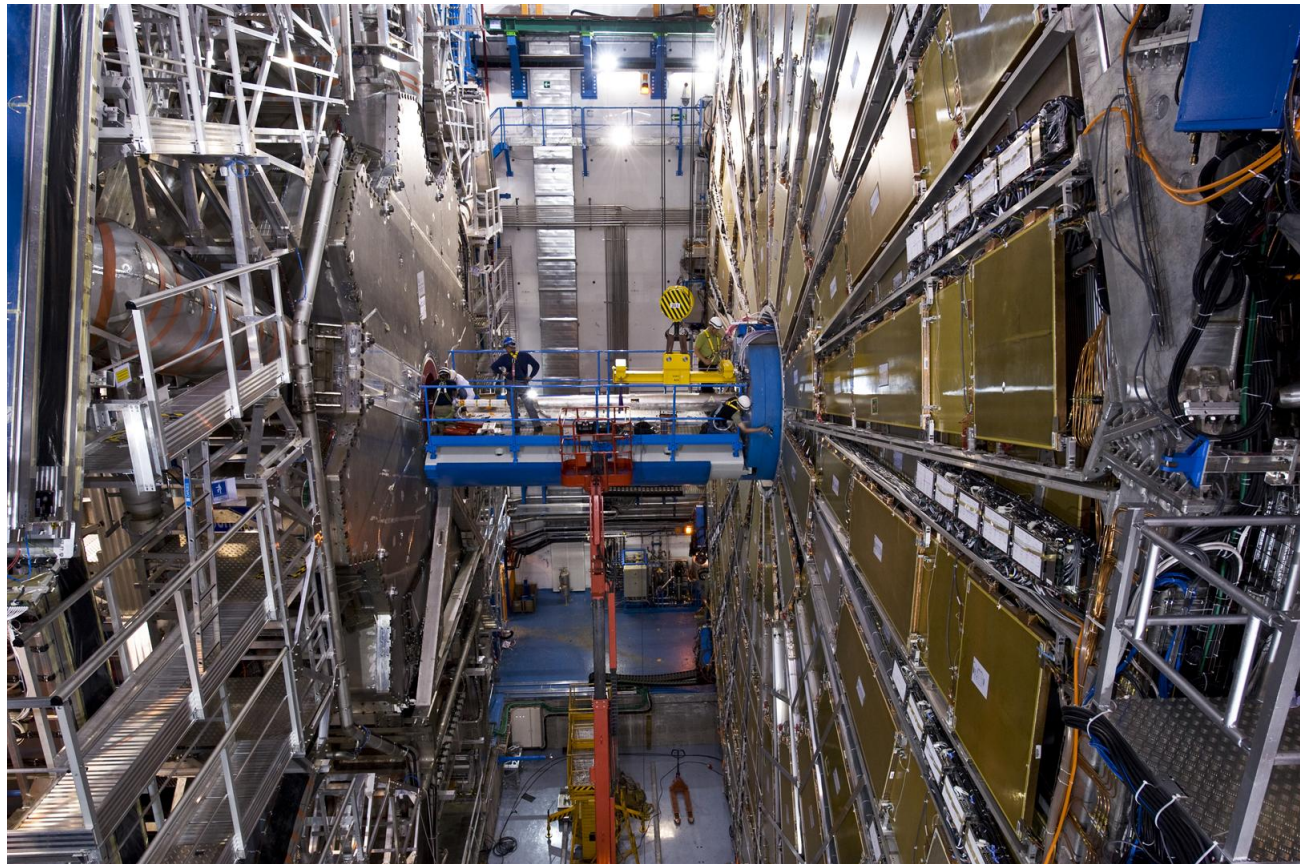

Think of the c-quark “orbiting” the b-quark – the two of them **bound by the strong force**. This is analogous to the electron “orbiting” the proton in hydrogen.

Recall that the energy levels of an electron bound to a nucleus are imposed by boundary conditions on the electron’s wavefunction in the field of the electromagnetic potential.

The bound quark system has energy levels too – also imposed by boundary conditions. What’s different is the potential, which in this case is strong, not EM.

In the hydrogen case: The electron's different energies are linked to being in different orbitals. The excited hydrogen does not have observably higher mass than the ground state, but its electron's radius is different. We name those excitations spectroscopically, $1s^1$, $1s^2$, $1p^1$, etc.

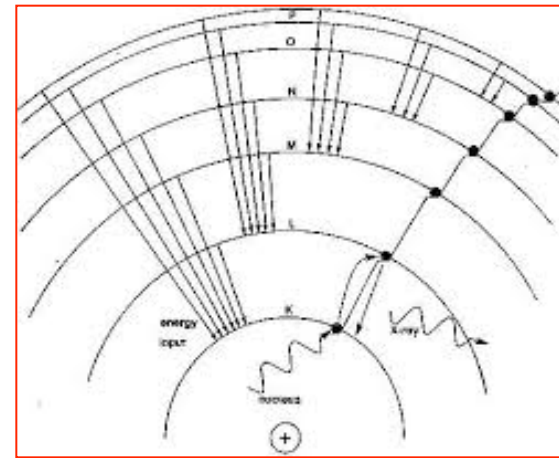

In the bound quark case: This system can take on different energies too, even though no electron is present. The quarks themselves form shells. When the system transitions to a higher shell, the system's mass changes observably. We name these states spectroscopically too. We record these different-mass states as distinctly different particles.

The theory that describes the strong interaction is Quantum Chromodynamics.

Like all theory, it evolves in response to data. *What input can the $B_c(2S)$ provide to it?*

Various approaches are used for QCD predictions. These are different ways of trying to calculate in a regime where perturbation theory may not work.

- The **lattice** approach discretizes spacetime, to avoid divergences that arise when 2 fields are evaluated at the same point.
- **Effective field theory** factorizes terms associated with different scales, retaining degrees of freedom relevant to phenomena in a range of interest.

The methods are different, but the goals are the same, e.g., predict what's observed, and then go beyond that.

They both need inputs from data.

Lattice calculations need to assume a lattice spacing, masses of the light quarks (u, d, s), and masses of the heavy quarks (c, b, t). **The b-quark mass, for example, is inferred from *measured masses of heavy mesons including members of the B_c family.***

Effective field theories typically include a potential that encodes the effect of degrees of freedom that have been integrated out (factorized) from full QCD. ***Heavy particle mass measurements are essential to mapping that strong potential.***

When we measure particle masses, we are measuring the energies of the stationary states that the strong potential supports. We know that the spectrum depends sensitively on the well shape, so **particle masses can tell us the shape of the strong potential....**

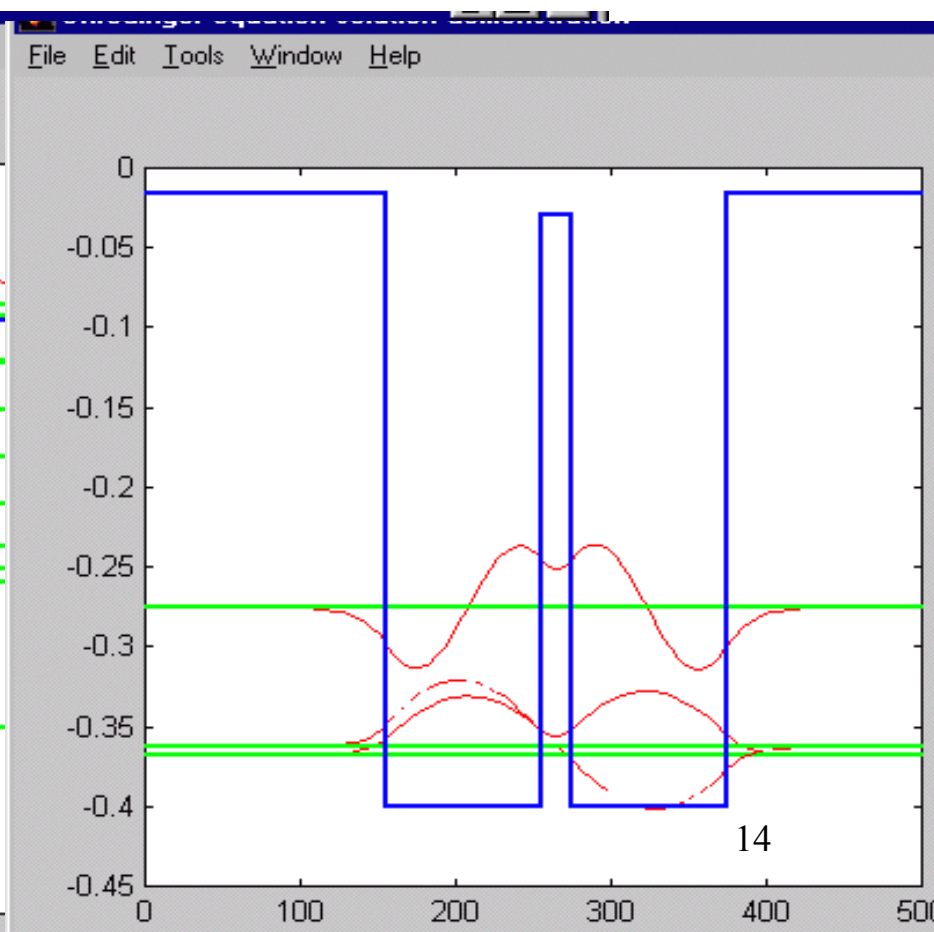
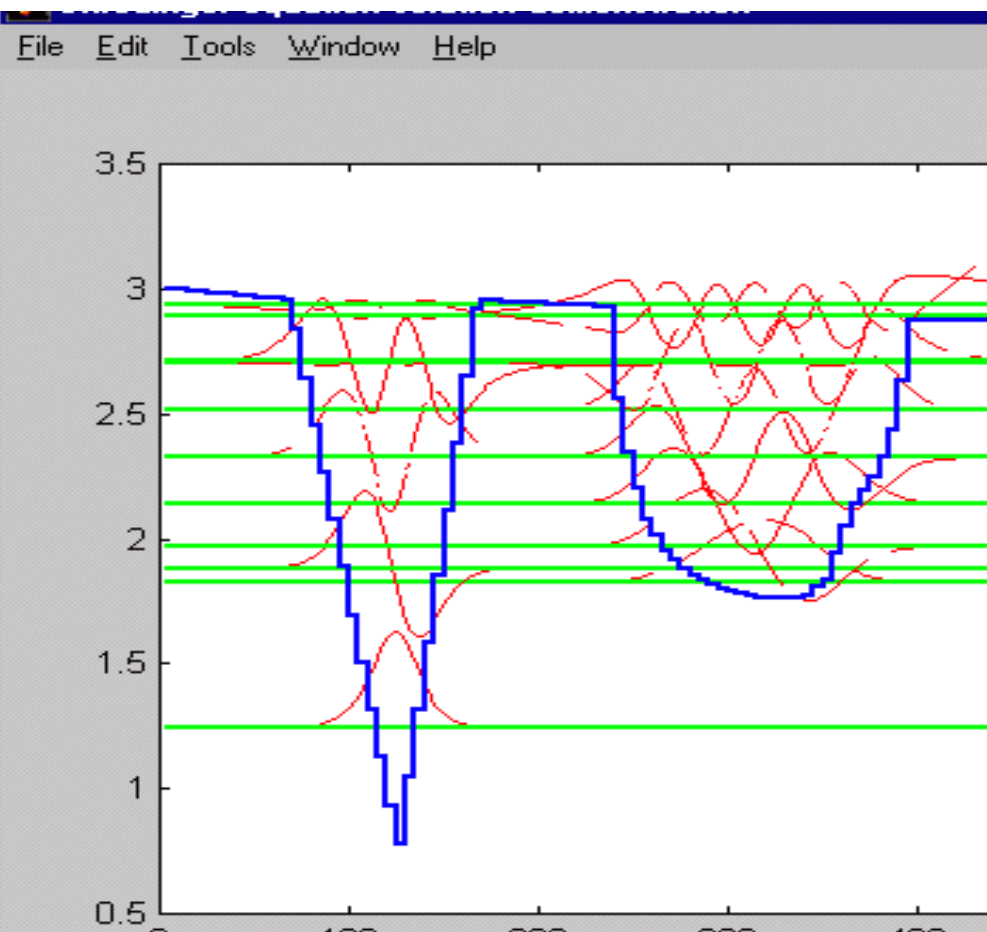

Here* are the first lattice predictions of excited B_c states' masses, including the $B_c(2S)$. These took input from other mesons and were predicted before the $B_c(2S)$ was discovered.

*R.J. Dowdall, et al., HPQCD Collaboration, Phys. Rev. D 86, 094510 (2012).

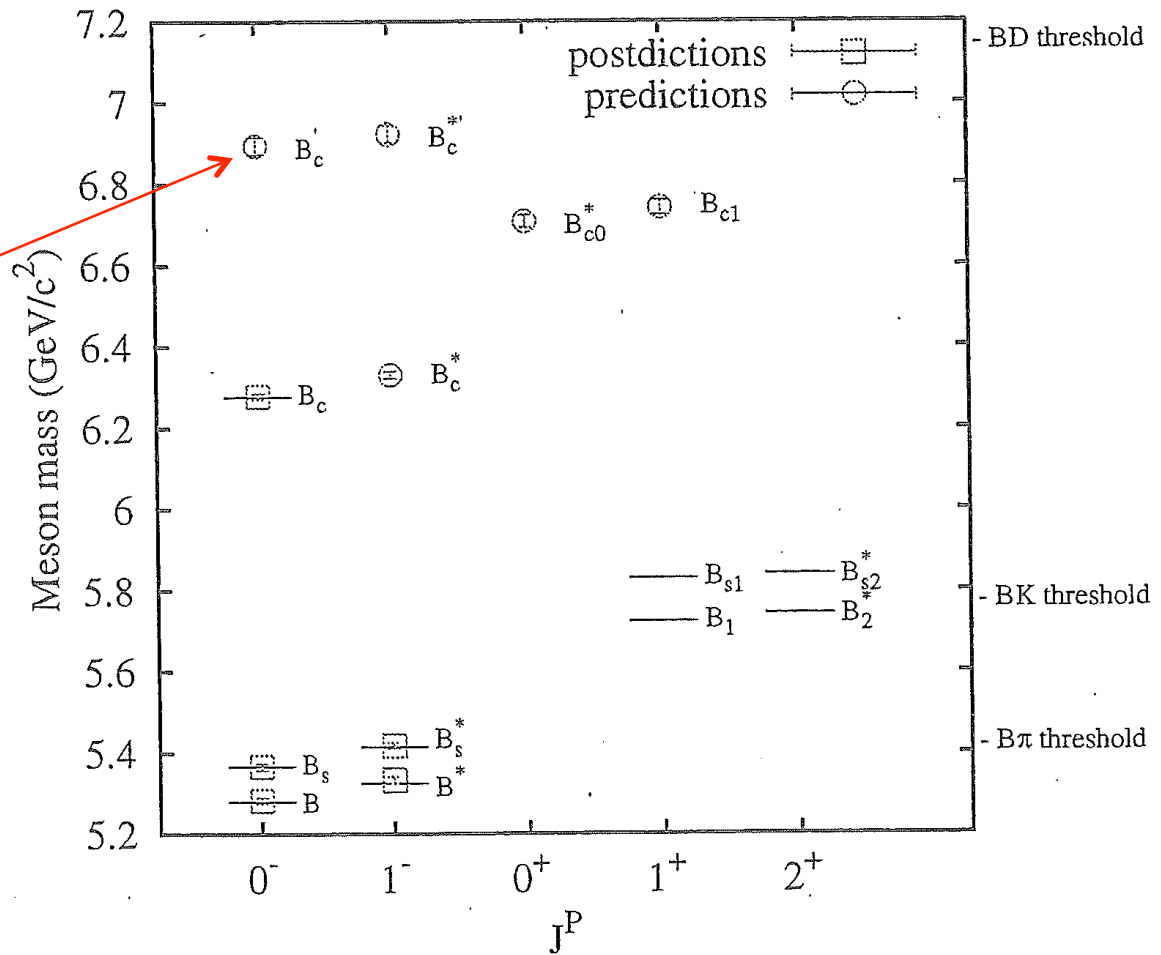
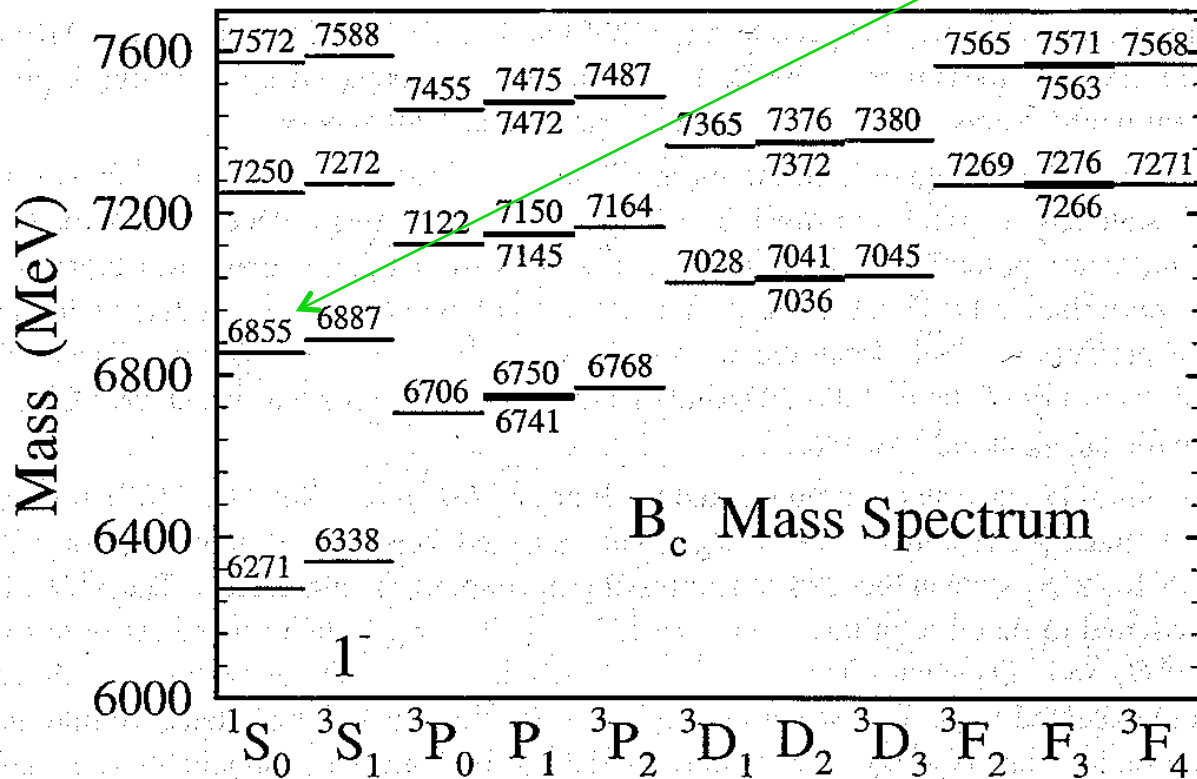

FIG. 17. The spectrum of gold-plated B , B_s and B_c meson states from this calculation, compared to experiment where results exist. Predictions are marked with open red circles. None of the meson masses included here were used to tune parameters of the action so all the masses are parameter-free results from lattice QCD.

Here are example predictions* for b-c bound state masses, based on an effective field theory. This includes the $B_c(2S)$ and was published long before the $B_c(2S)$ discovery.



*(Godfrey and Isgur, Phys. Rev. D 32, 189 (1986))

Fig. 3.9: B_c spectrum.

The mass of the *ground state* B_c has been measured at the LHC and the Tevatron. Those data challenge the theories:

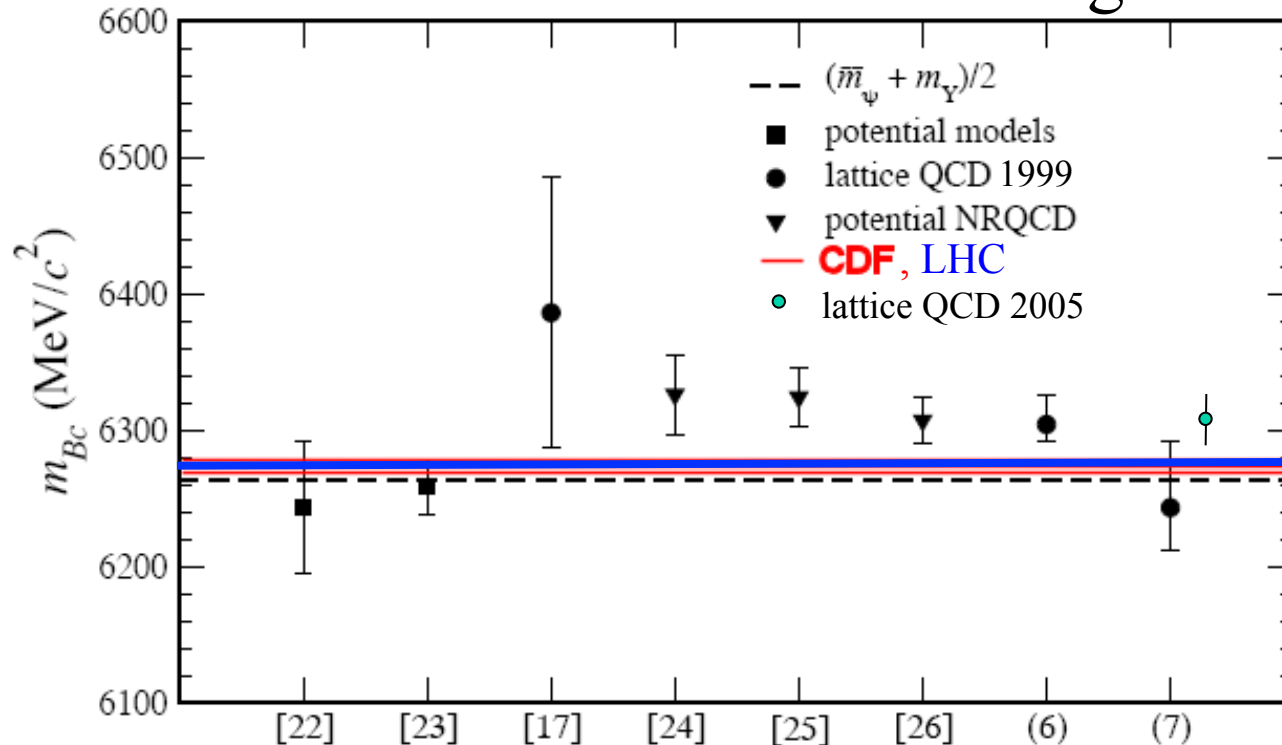

$$\text{measured mass } (B_c)_{\text{CDF}} = 6275.6 \pm 2.9 \pm 2.5 \text{ MeV}/c^2$$

$$\text{measured mass } (B_c)_{\text{LHCb}} = 6276.28 \pm 1.44 \pm 0.36 \text{ MeV}/c^2$$

So we proceed to the $B_c(2S)$

We reconstruct the $B_c(2S)$ through its $B_c(2S) \rightarrow B_c \pi^+ \pi^-$ channel.

Predictions of its mass range over 6835-6917 MeV.

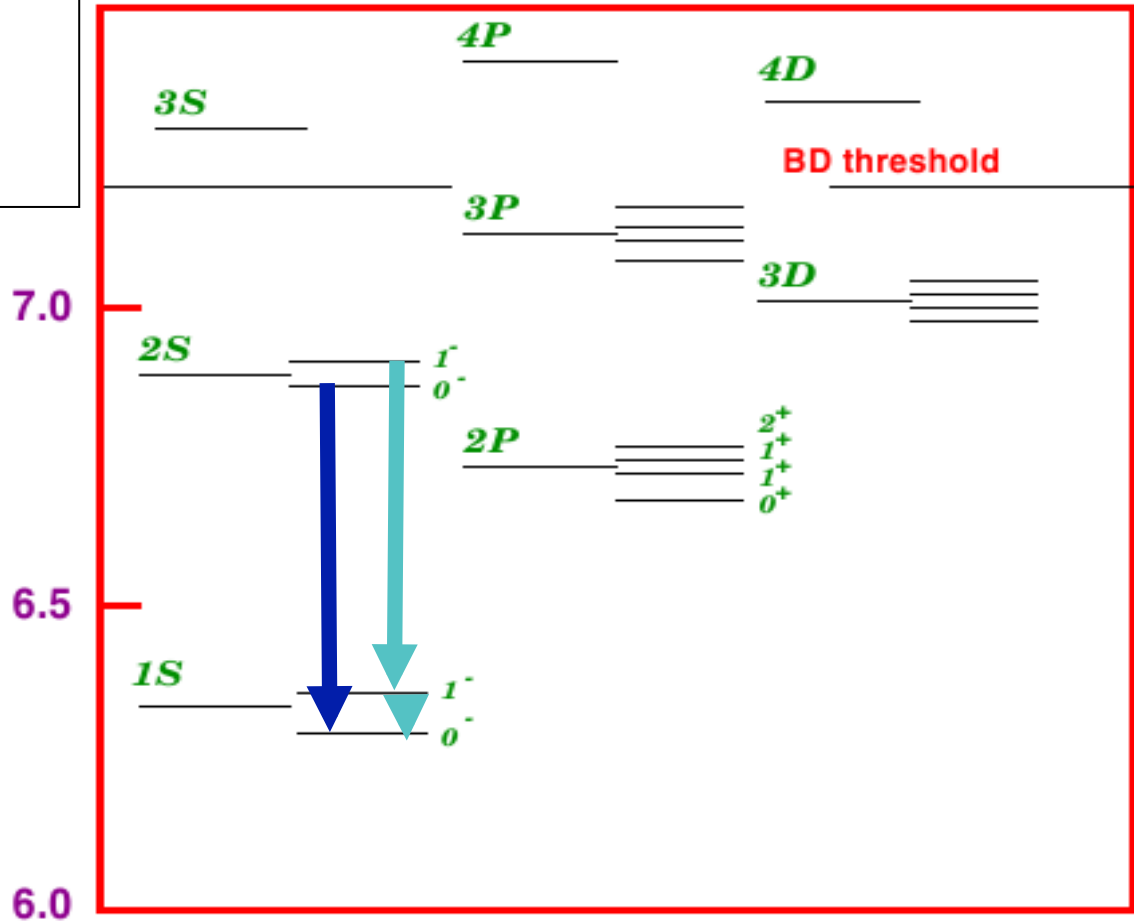
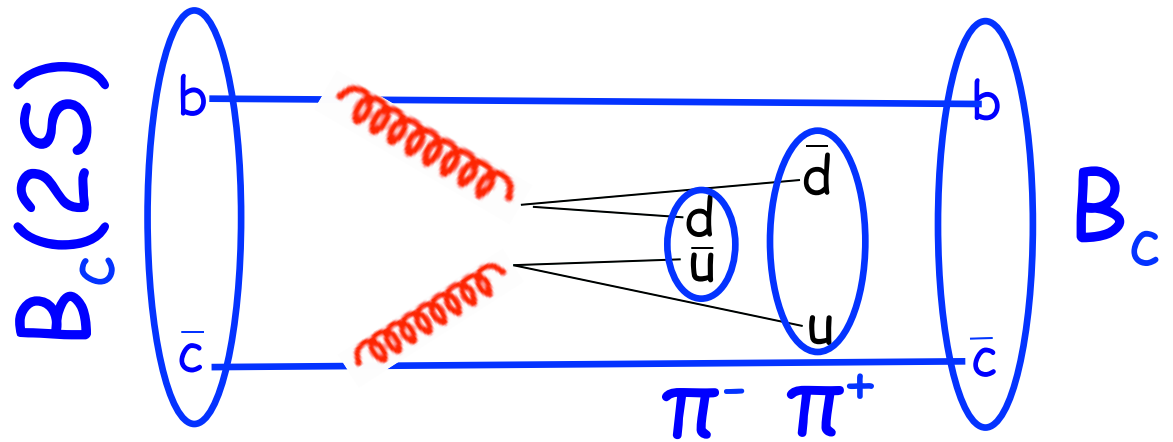

So to find the $B_c(2S)$, we need to reconstruct the B_c ground state first.

We look for this:

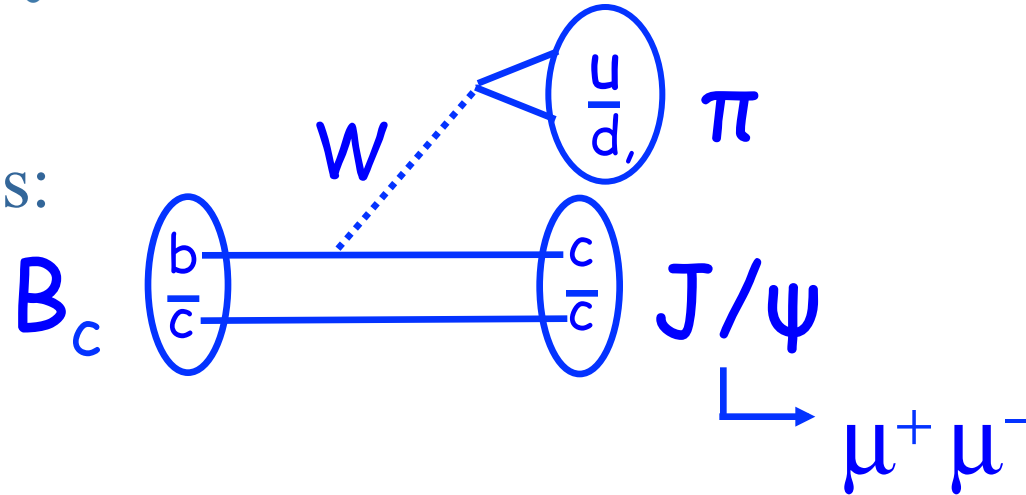

At the LHC it looks like this:

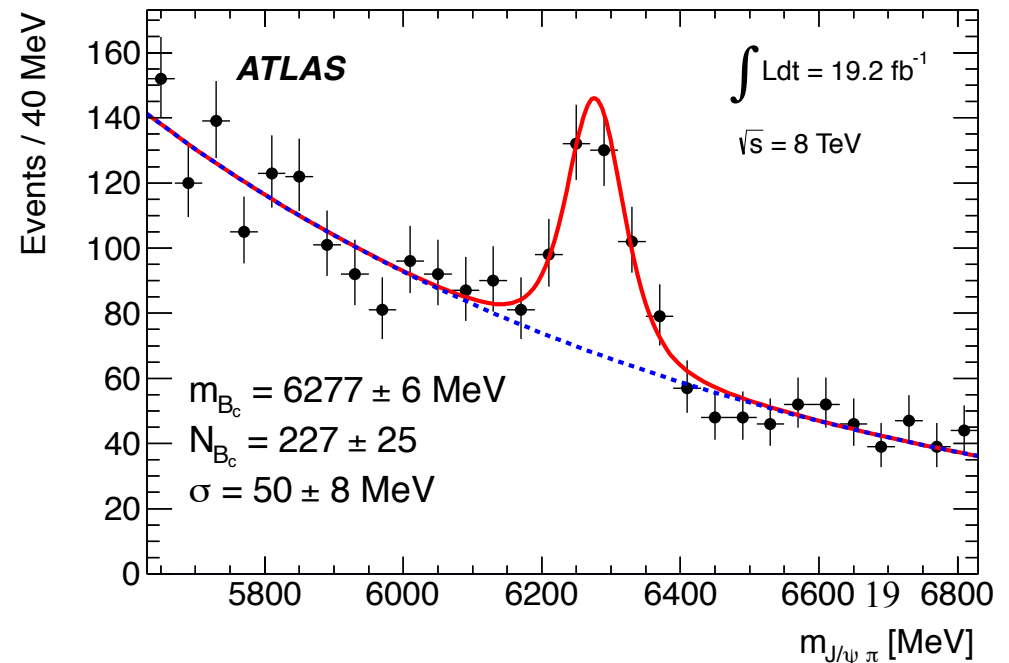

Once we have those B_c 's, we combine them with 2 more pions to look for this:

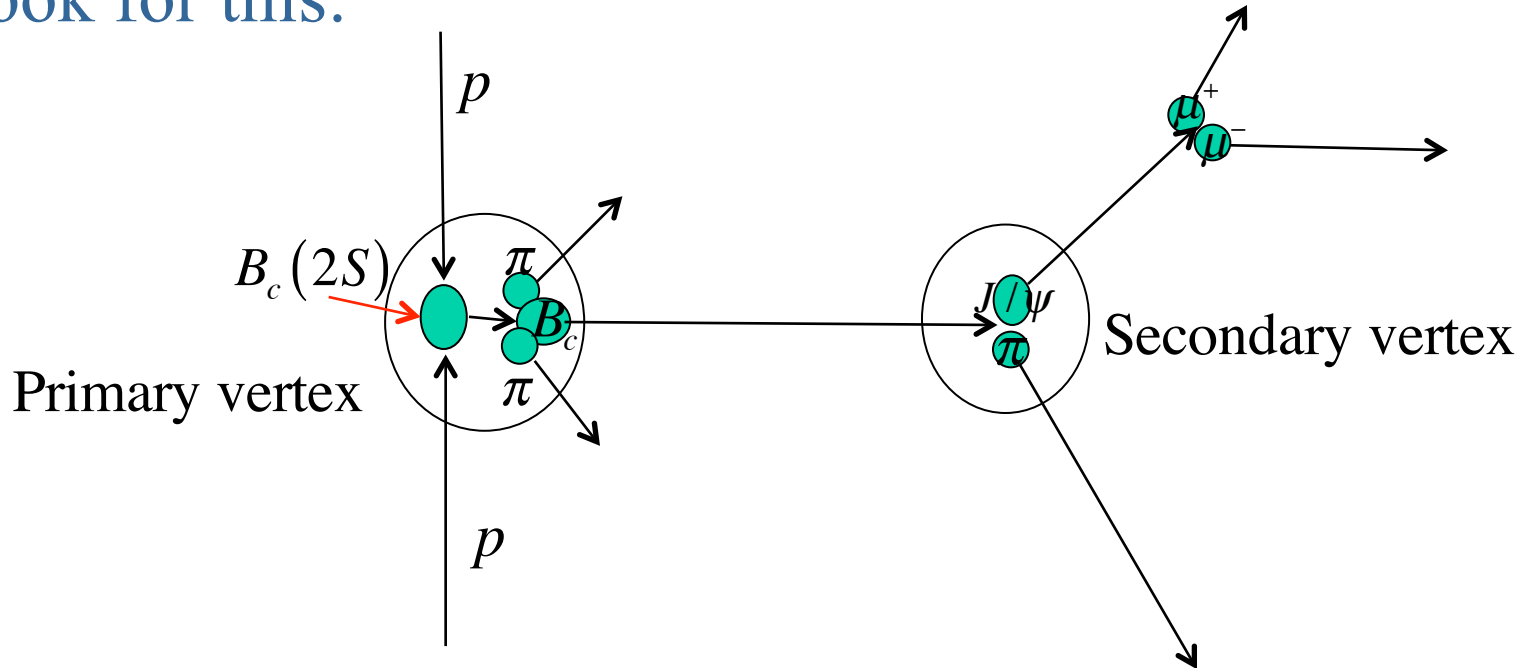

The critical step in reconstructing the $B_c(2S)$ final state is recognizing the fact that the J/ψ is produced at a different vertex than the point of the primary collision. *The open circles here represent schematically the detector's position resolution, 10's of microns.*

That distance between the primary and secondary vertices is resolved in the Pixel Detector at the heart of ATLAS.

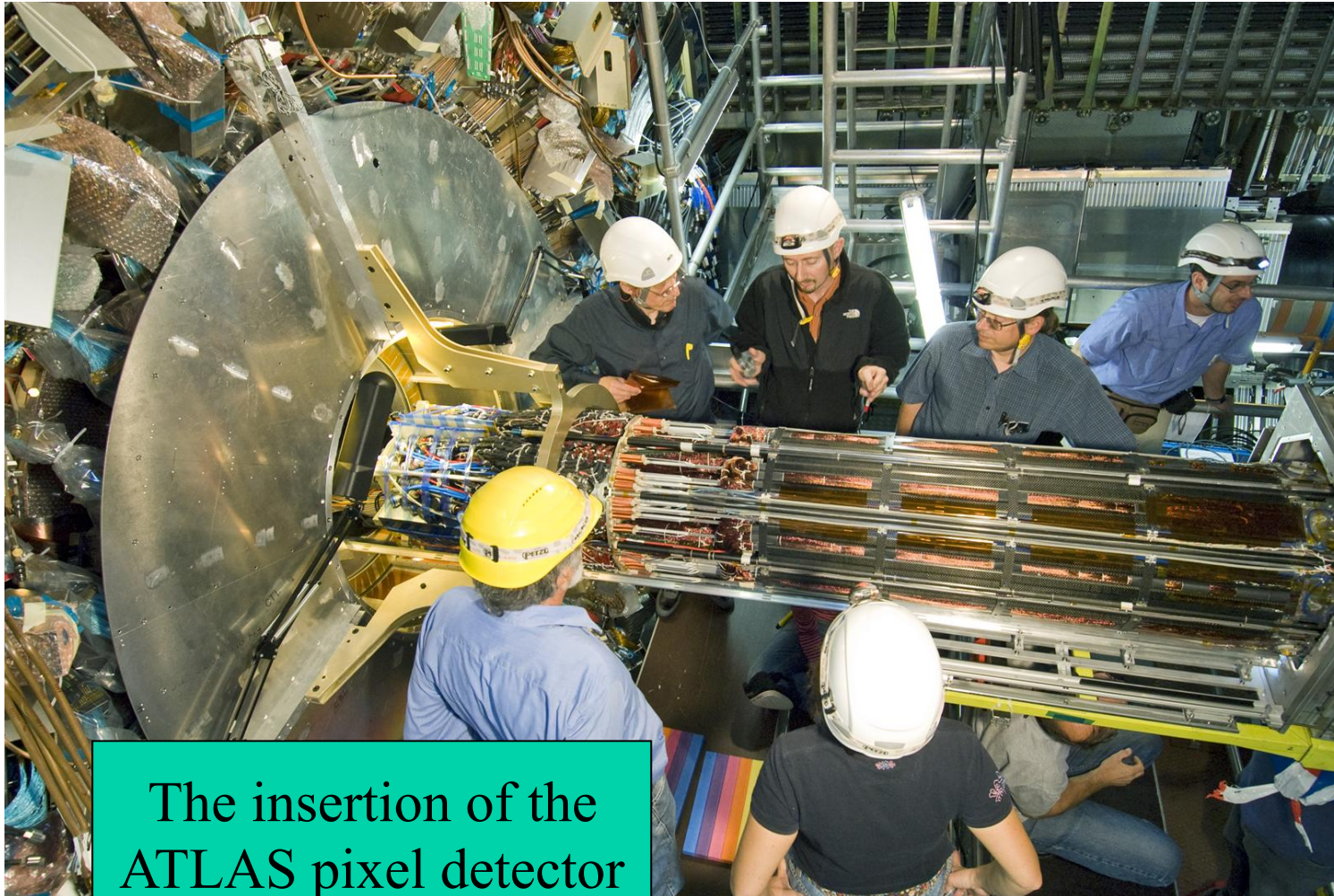

Members of the UNM-ATLAS group contributed to the design and testing of the ATLAS pixel sensors.

The insertion of the ATLAS pixel detector

To minimize systematic uncertainty, we compute the difference Q between the mass of the reconstructed $B_c(2S)$ and the sum of the masses of the decay products:

$$Q \equiv m(B_c \pi \pi) - m(B_c) - 2m(\pi)$$

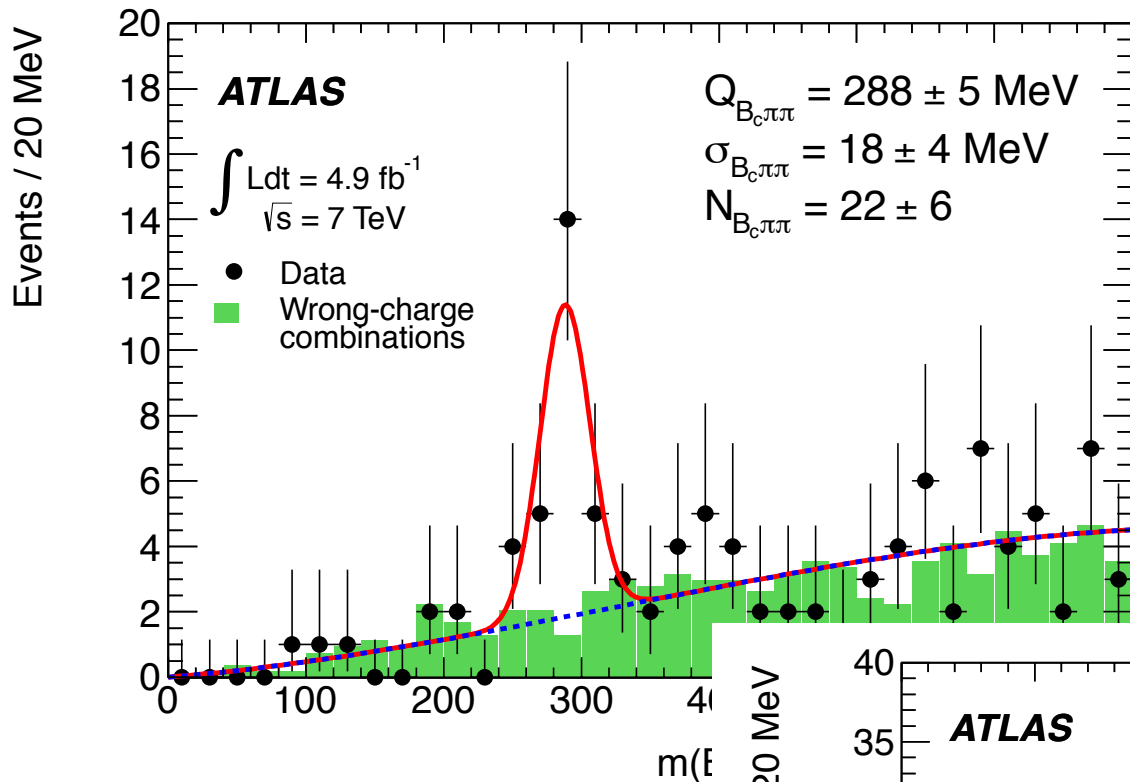

We observe the peak at the same point in 2 independent ATLAS

datasets:

← $\sqrt{s} = 7 \text{ TeV}$ and 8 TeV

Peak at $Q = 288 \text{ MeV}$.
 The mass of the new particle:

$$m(B_c(2S)) = Q + m(B_c) + 2m(\pi) = 6842 \pm 7 \pm 4 \text{ MeV}$$

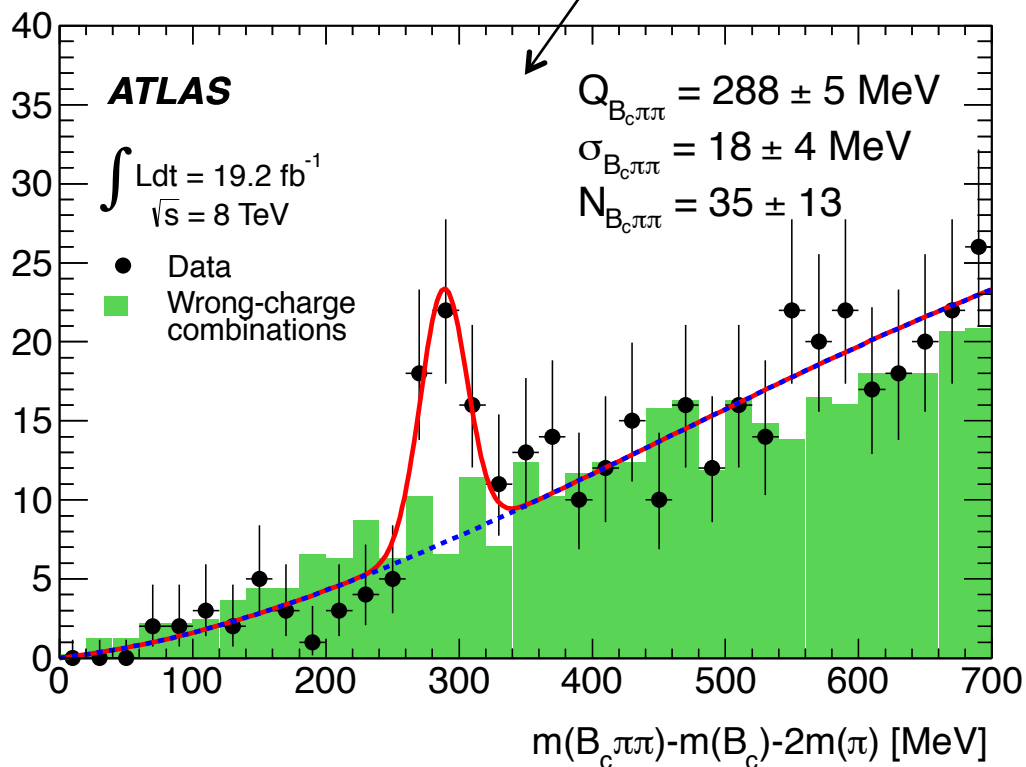

All of the new particle bound states make contributions to QCD theory like this, for example,

Pentaquarks: what is the configuration of this state?

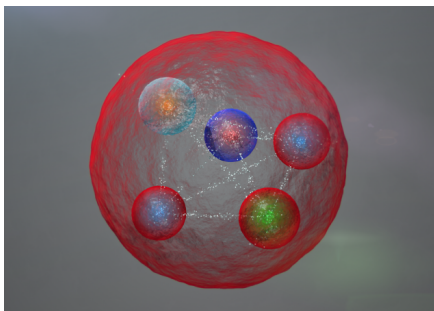

or ?

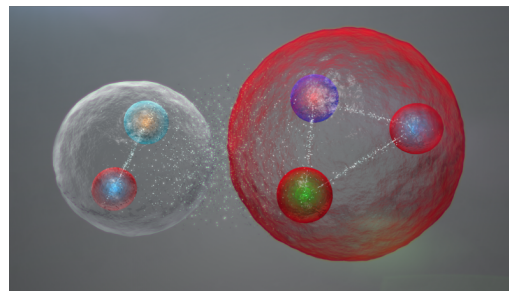

Tetraquarks: what is the role of correlations as the quarks maintain color neutrality?

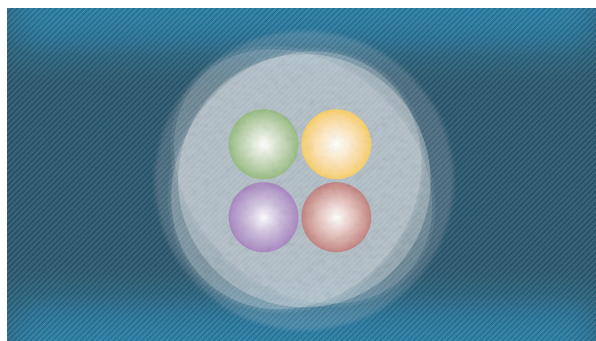

Those are interesting topics for other talks...

A few conclusions...

- ❖ New bound states are being observed at the LHC: heavy mesons, heavy baryons, and tetraquarks and pentaquarks containing heavy quarks.
- ❖ Each one has a contribution to make to our understanding of the strong interaction. An example is provided for the $B_c(2S)$, the first excited state of the B_c meson.
- ❖ The opportunity to deepen our understanding of the Strong Force has never been better.
- ❖ There is even more to see at the LHC than the Higgs.